

## IS810N Multi-Axes Servo Drive Platform

For maximum performance in the most demanding applications

- Three phase 380-480 V supply voltage
- Single and dual axes modules: 850 W - 75 kW\*
- Common power supply module

\*dual axes available up to 18.5 kW

EtherCAT<sup>®</sup>





# IS810N features and functions

Designed for high performance, multi-axes applications

IS810N is a modular, scalable servo platform designed for the most complex and demanding industrial applications



- ✓ Advanced functionality
- ✓ Single and dual axes modules available
- ✓ Energy saving with common DC bus
- ✓ Robust design: conformal coating
- ✓ Easy & flexible integration
- ✓ Reduced installation costs
- ✓ Easy commissioning & maintenance



**4.5 kHz current loop bandwidth**

**STO SIL3 according to: EN/IEC 61800-5-2**

**Complete EtherCAT functionality**

**Remote service and maintenance with dedicated Ethernet port**

High dynamic performance with ultra-fast current loop

IS810N meets the needs of European OEM manufacturers of high performance precision machinery. To develop IS810N, Inovance Technology Europe implemented a co-design process that brought together best-in-class R&D knowhow from engineering centres in Europe and Asia.



Packaging



Printing



Milling



Textiles

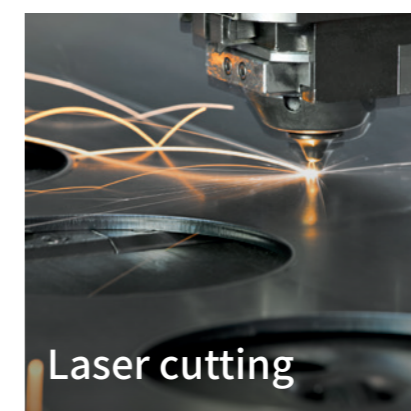

Laser cutting

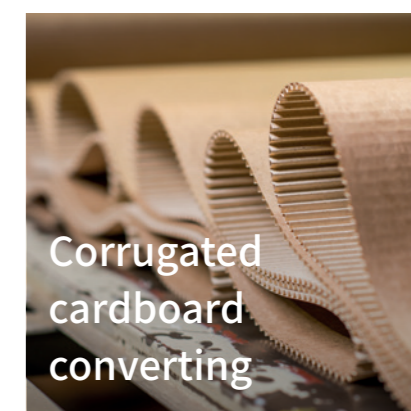

Corrugated cardboard converting

# IS810N – advanced multi-axes servo platform

## Dynamic performance with ultra-fast current loop

IS810N's 4.5 kHz current loop bandwidth allows the motor to follow the motion profile with minimal error.

The drive has achieved perfect synchronization and higher stability by eliminating all delay between the speed loop and current loop.

The result is radically improved system performance with a shorter settling time and higher throughput. In case of mechanical resonance, high performance can be ensured through use of notch filters (up to four notch filters are available for simultaneous use if necessary).



# IS810N – advanced multi-axes servo platform

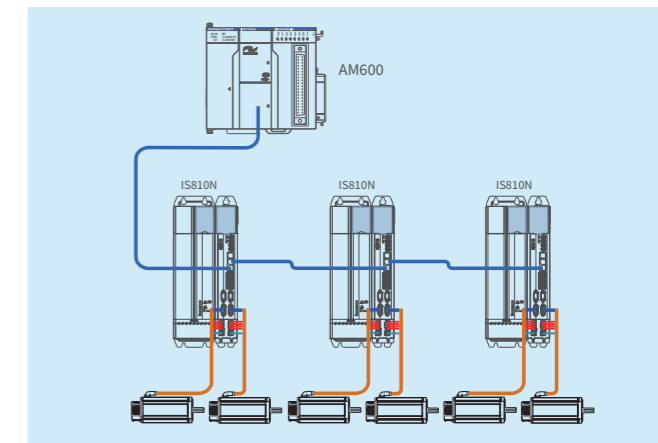
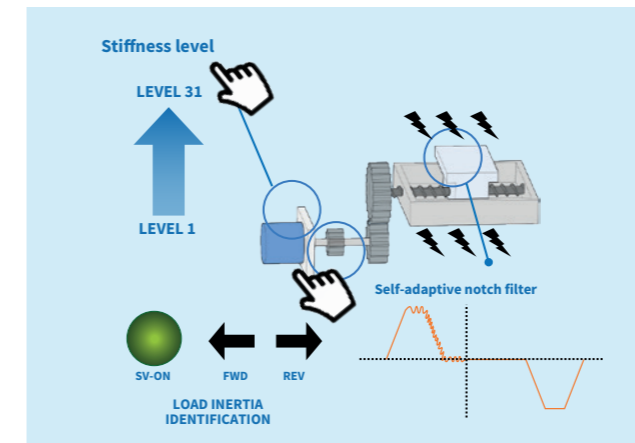

## Complete EtherCAT functionality

The EtherCAT CiA Drive Profile 402 contains all seven motion profiles. Additionally, the SYNC object enables precise operation of the EtherCAT distributed clock to allow perfect synchronisation between drives. Meanwhile, a dedicated Ethernet port with a Modbus TCP/IP protocol allows efficient servicing and commissioning through the InoDriverShop PC tool.

Please note: a CANopen slave protocol is supported by the IS810P variant

## Easy commissioning with smart tuning functions

Machine performance can be optimized by using IS810N's automatic gain function to set the stiffness level to achieve fast response and stability.

- Online and offline load inertia identification
- Automatically adjust speed and position loop gains by setting the stiffness level
- Automated detection of vibration frequency allows notch filter to be automatically set
- Damping filter suppresses vibrations with a characteristic frequency of 1-100 Hz

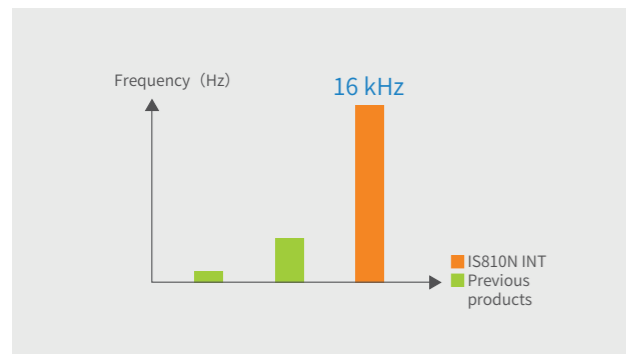

Speed and position loop cycle time: 62.5  $\mu$ s

4 times faster than previous generation products

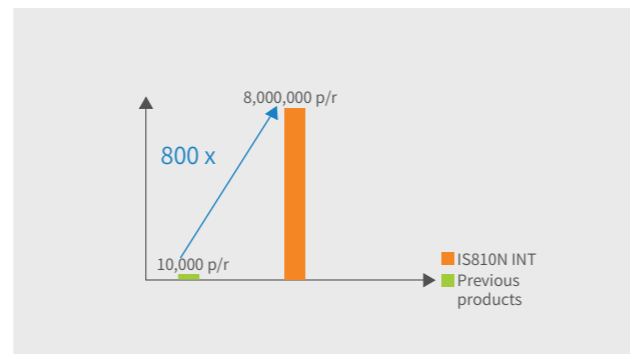

Matches with 23 bit absolute encoder

Equivalent resolution of 0.15 arc seconds

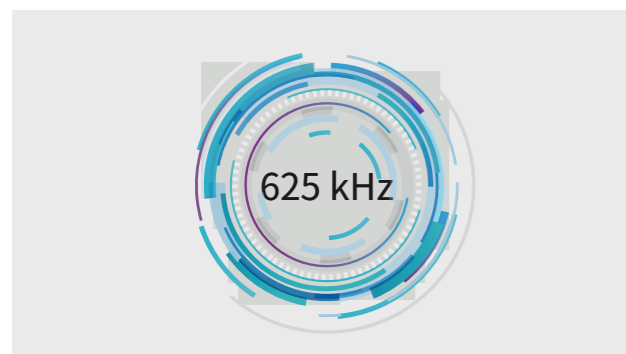

Current loop cycle time: 1.6  $\mu$ s

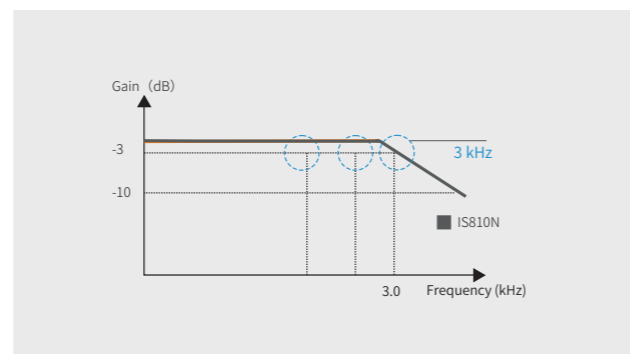

3 kHz speed loop bandwidth

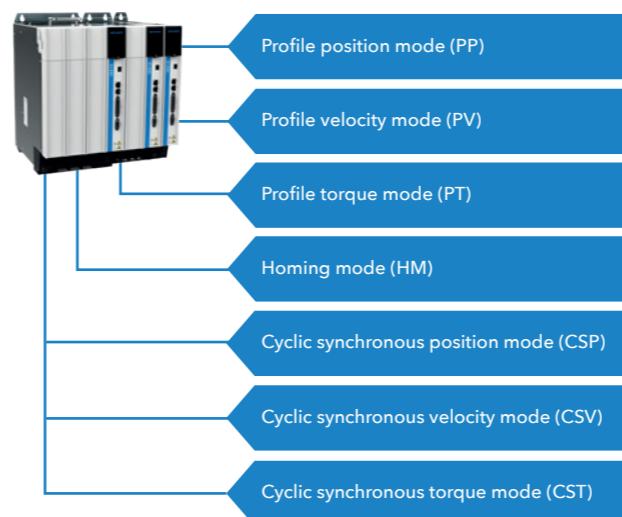

Seven CiA 402 motion profiles are supported

## Remote service and maintenance

An Ethernet port with Modbus TCP/IP protocol is available for commissioning, remote monitoring, diagnostics and maintenance.

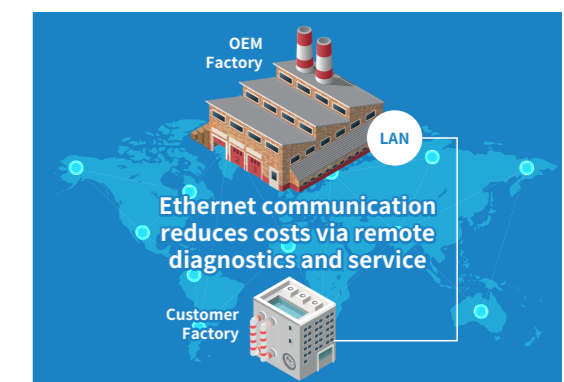



# The IS810N multi-axes solution

## Product overview

**SIL3**  
Safety Integrity Level

IS810N series servo drive key features	
<b>High performance</b>	
Circle	Current loop bandwidth > 4 kHz *1
Circle	Speed loop bandwidth > 2 kHz *1
<b>Safety on board</b>	
Circle	Dual input for STO function (SIL 3)
<b>Digital I/O</b>	
Circle	6 DI (2 fast inputs) + 2 DO
<b>Power supply voltage range</b>	
Circle	Three phase AC 380 V ~ 480 V, +10 ~ -15%, -50/60 Hz
<b>Network</b>	
Circle	EtherCAT® - CiA 402 motion profiles: PP, PV, PT, HM, CSP, CSV, CST
Circle	Ethernet Modbus TCP/IP
<b>Easy to use</b>	
Circle	Fine tuning with PC software (InoDriverShop)
<b>Smart tuning</b>	
Circle	Inertia auto-tuning (on-line/off-line)
Circle	Automatic loop gains tuning
Circle	Adaptive notch filter (4 filters available)
Circle	Automatic/manual damping filter for low frequency resonance
Circle	Biquad filter

\*1 - Maximum theoretical performance achievable by the drive

Ultra-fast current loop (>4 kHz bandwidth)

23 bit serial single/multi-turn absolute encoders

Endat 2.2 encoder interface available



## IS810N – 2 axes in 1 module

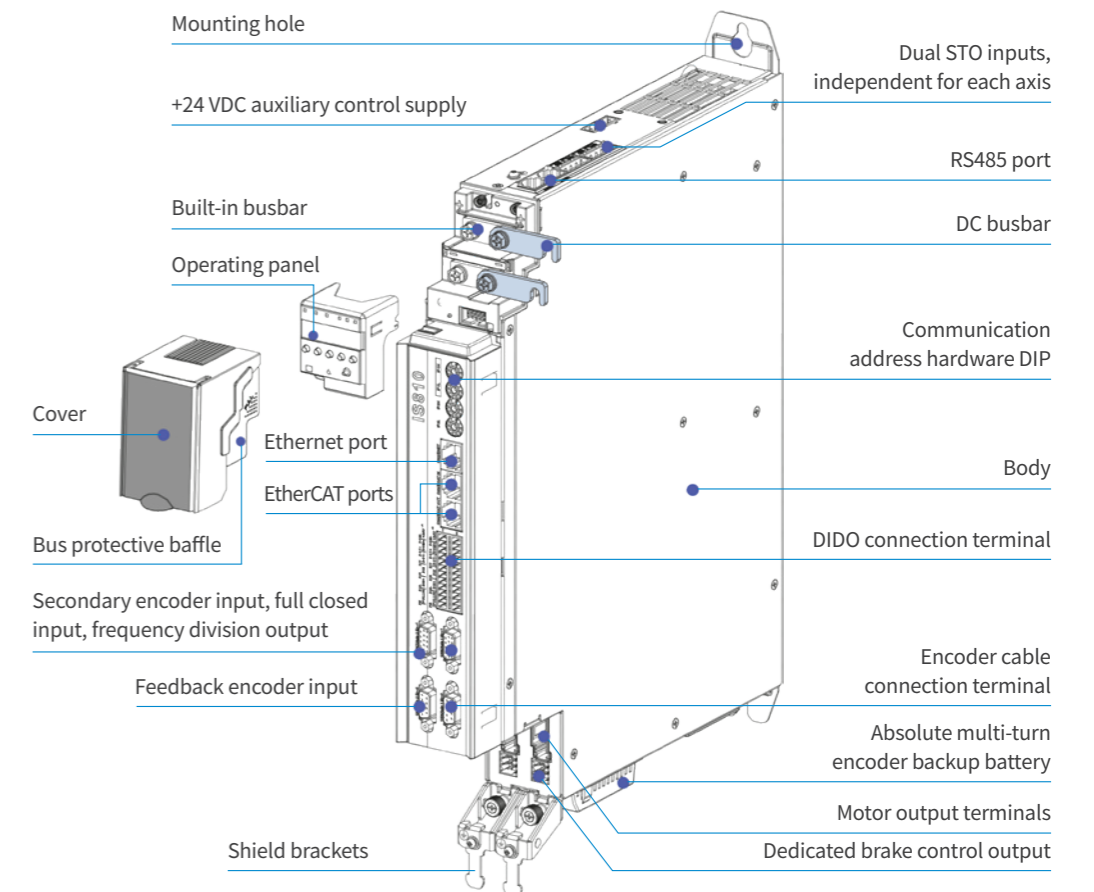

# PC software tools

## InoDriverShop

InoDriverShop is Inovance's PC-based software offering. It is based on a familiar Windows interface. InoDriverShop can upload and download drive parameters, and features a variety of other functions, such as a real-time oscilloscope, commissioning tools (e.g. inertia auto-tuning), and online software upgrades.

### Upload parameters from the drive

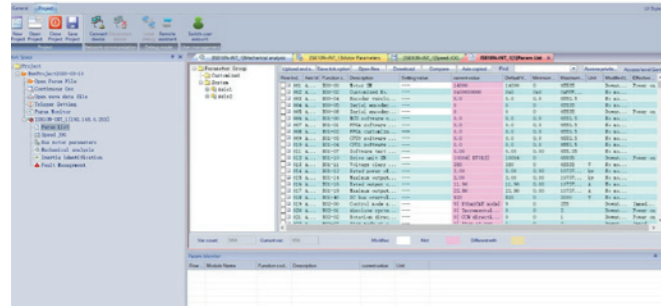

### Inertia auto-tuning

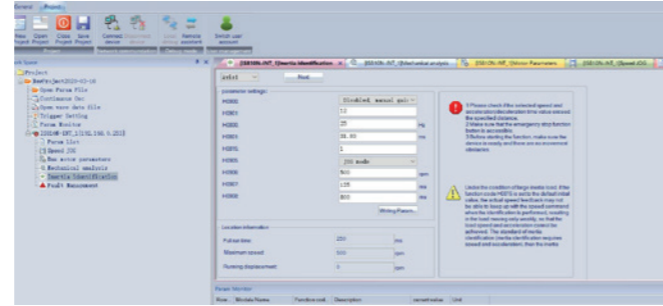

### Real-time oscilloscope

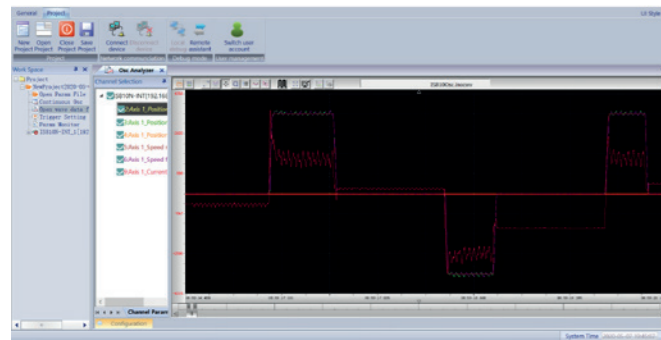

### Drive selection tool

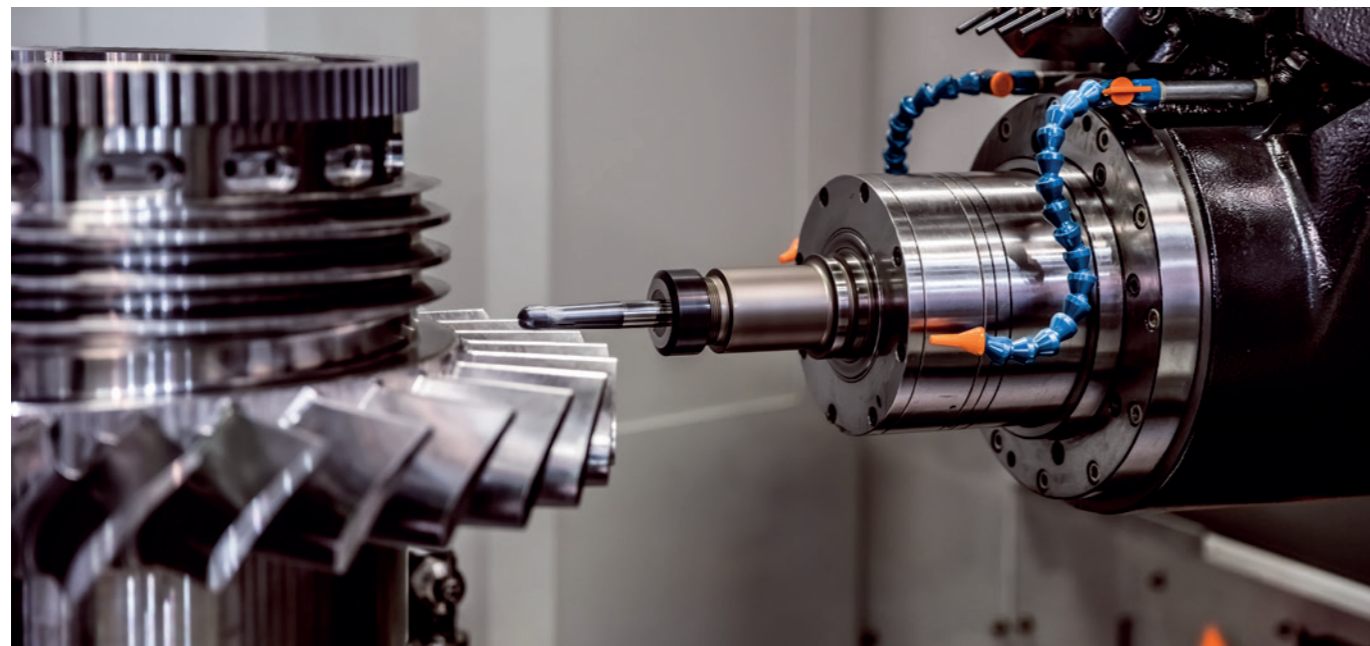
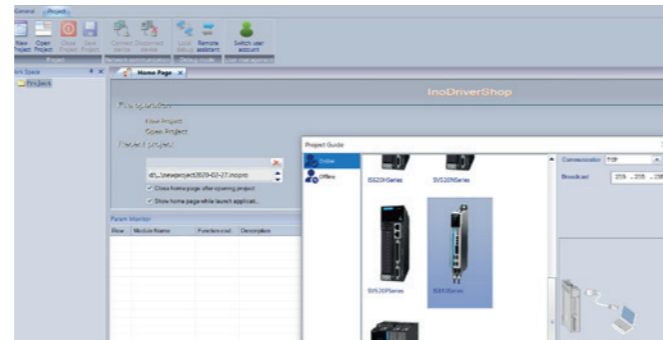

# IS810N drive Product ordering code

IS810 N 50M 4T D 3R5 INT

① ② ③ ④ ⑤ ⑥ ⑦

- ① **Servo drive series:**  
IS810
- ② **Control board type:**  
N: Ethercat
- ③ **Module type:**  
50M: drive
- ④ **Voltage supply:**  
4T: 380-480 V
- ⑤ **Drive module type:**  
S: single  
D: dual
- ⑥ **Rated current:**  
3R5 3.5 A 037 37 A  
5R4 5.4 A 045 45 A  
8R4 8.4 A 060 60 A  
012 11.9 A 075 75 A  
017 16.5 A 091 91 A  
021 20.8 A 112 112 A  
026 25.7 A 152 152 A  
032 32 A
- ⑦ **Model:**  
INT: international edition

# MD810 rectifier Product ordering code

MD810 - 20M 4T 45 G 1 0 0 - INT

① ② ③ ④ ⑤ ⑥ ⑦ ⑧ ⑨

- ① **Rectifier series:**  
MD810
- ② **Module type:**  
20M: rectifier
- ③ **Voltage supply:**  
4T: 380-480 V
- ④ **Rectifier (rated power):**  
22: 22 kW  
45: 45 kW  
110: 110 kW  
160: 160 kW  
355: 355 kW
- ⑤ **Model**  
G: general model
- ⑥ **Optional functional component**  
**Rectifier:**  
0: without built-in braking unit  
1: with built-in braking unit (22 & 45 kW only)
- ⑦ **Optional communication component**  
**Rectifier:**  
0: built-in RS485 (Modbus-RTU), CANopen and CANlink communications
- ⑧ **Optional features**  
**Rectifier:**  
0: no optional features available
- ⑨ **Model:**  
INT: international edition

# IS810N ratings

## Single drives

Model	Size	Rated power (kW)	Rated input DC current (A)	Rated output AC current (A)	Peak output AC current for 3 s (A)
Input voltage: 537-679 VDC (operating range: 350-800 VDC); output voltage: 0-480 VAC					
IS810N50M4TS3R5INT	1 (50 mm)	0.85	5	3.5	8.5
IS810N50M4TSSR4INT		1.3	7	5.4	14
IS810N50M4TSR4INT		1.8	12	8.4	20
IS810N50M4TS012INT		2.9	17	12	28
IS810N50M4TS017INT	2 (100 mm)	4.4	22	16.5	42
IS810N50M4TS021INT		5.5	27	20.8	55
IS810N50M4TS026INT		7.5	31	25.7	65
IS810N50M4TS032INT		15	40	32	80
IS810N50M4TS037INT	3 (200 mm)	18.5	46	37	92.5
IS810N50M4TS075INT-P		37	90	75	187.5
IS810N50M4TS090INT		45	105	91	227.5
IS810N50M4TS112INT		55	129	112	280
IS810N50M4TS152INT		75	172	152	380

## Dual drives

Model	Size	Rated power (kW)	Rated input DC current (A)	Rated output AC current (A)	Peak output AC current for 3 s (A)
Input voltage: 537-679 VDC (operating range: 350-800 VDC); output voltage: 0-480 VAC					
IS810N50M4TD3R5INT	1 (50 mm)	0.85	10	3.5	8.5
IS810N50M4TDSR4INT		1.3	14	5.4	14
IS810N50M4TDBR4INT		1.8	24	8.4	20
IS810N50M4TD012INT		2.9	34	12	28
IS810N50M4TD017INT	2 (100 mm)	4.4	44	16.5	42
IS810N50M4TD021INT		5.5	54	20.8	55
IS810N50M4TD026INT		7.5	62	25.7	65
IS810N50M4TD032INT		15	80	32	80
IS810N50M4TD037INT		18.5	92	37	92.5

## Rectifiers

Model	Size	Rated power (kW)	Rated input AC current (A)	Rated output DC current (A)	Braking unit
MD810-20M4T22G1XX-INT	1 (50 mm)	22	59	56	Built-in
MD810-20M4T45G1XX-INT	2 (100 mm)	45	112	110	Built-in
MD810-20M4T110G0XX-INT	3 (200 mm)	110	196	240	MDBUN-60-(5)T x 2
MD810-20M4T160G0XX-INT	4 (300 mm)	160	292	358	MDBUN-90-(5)T x 2
MD810-20M4T355G0XX-INT	5 (180 mm)	355	619	759	MDBUN-200-(5)T x 3

\*Please note: for ISMG motor order codes, please consult with your local Inovance representative



# Overview of IS810N series servo drives

## Dimensions of single drive units

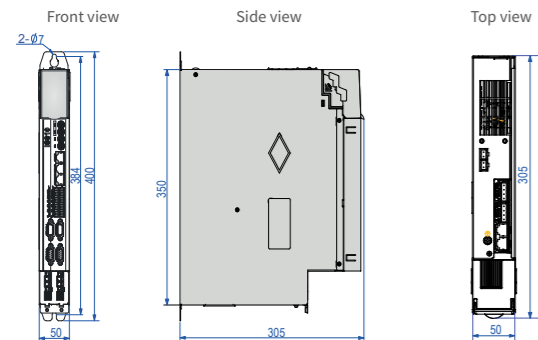

Drive unit model (size 1)	Physical dimensions (mm)				Mounting hole (mm)			Mounting hole diameter (mm)	Mass (kg)
	(H2)	(H)	(W)	(D)	(W1)	(W2)	(H1)		
IS810N50M4TS3R5INT	400	350	50	305	-	-	384	Φ7	4.1
IS810N50M4TS5R4INT	400	350	50	305	-	-	384	Φ7	4.1
IS810N50M4TS8R4INT	400	350	50	305	-	-	384	Φ7	4.1
IS810N50M4TS012INT	400	350	50	305	-	-	384	Φ7	4.1

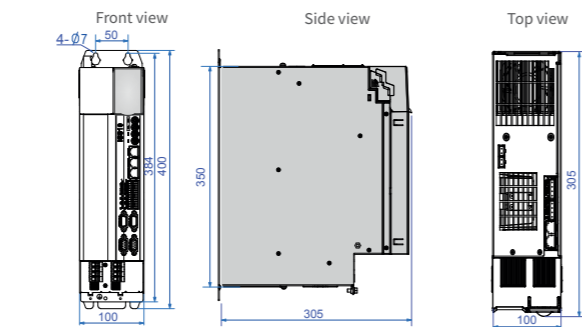

Drive unit model (size 2)	Physical dimensions (mm)				Mounting hole (mm)			Mounting hole diameter (mm)	Mass (kg)
	(H2)	(H)	(W)	(D)	(W1)	(W2)	(H1)		
IS810N50M4TS017INT	400	350	100	305	50	-	384	Φ7	6.8
IS810N50M4TS021INT	400	350	100	305	50	-	384	Φ7	6.8
IS810N50M4TS026INT	400	350	100	305	50	-	384	Φ7	6.8
IS810N50M4TS032INT	400	350	100	305	50	-	384	Φ7	6.8
IS810N50M4TS037INT	400	350	100	305	50	-	384	Φ7	7.4

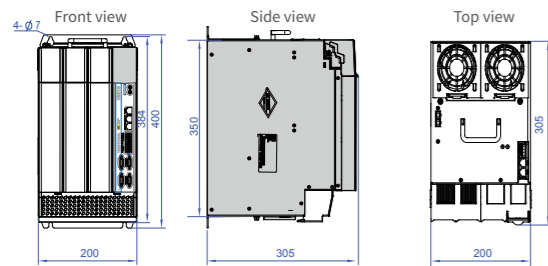

Drive unit model (size 3)	Physical dimensions (mm)				Mounting hole (mm)			Mounting hole diameter (mm)	Mass (kg)
	(H2)	(H)	(W)	(D)	(W1)	(W2)	(H1)		
IS810N50M4TS075INT-P	400	350	200	305	150	-	384	Φ7	16.4
IS810N50M4TS090INT	400	350	200	305	150	-	384	Φ7	16.4
IS810N50M4TS112INT	400	350	200	305	150	-	384	Φ7	17.8
IS810N50M4TS152INT	400	350	200	305	150	-	384	Φ7	18.8

## Dimensions of dual drive units

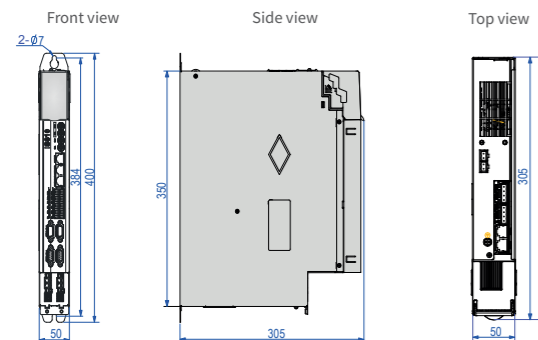

Drive unit model (size 1)	Physical dimensions (mm)				Mounting hole (mm)			Mounting hole diameter (mm)	Mass (kg)
	(H2)	(H)	(W)	(D)	(W1)	(W2)	(H1)		
IS810N50M4TD3R5INT	400	350	50	305	-	-	384	Φ7	4.4
IS810N50M4TDSR4INT	400	350	50	305	-	-	384	Φ7	4.4
IS810N50M4TDSR4INT	400	350	50	305	-	-	384	Φ7	4.4
IS810N50M4TD012INT	400	350	50	305	-	-	384	Φ7	4.4

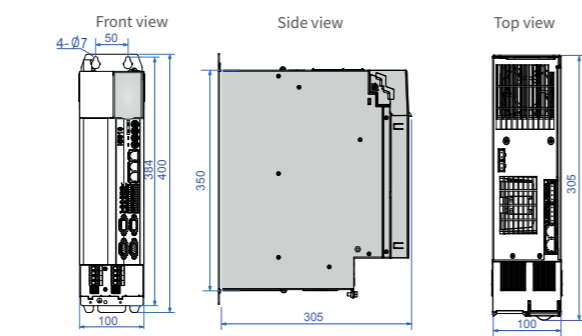

Drive unit model (size 2)	Physical dimensions (mm)				Mounting hole (mm)			Mounting hole diameter (mm)	Mass (kg)
	(H2)	(H)	(W)	(D)	(W1)	(W2)	(H1)		
IS810N50M4TD017INT	400	350	100	305	50	-	384	Φ7	7.2
IS810N50M4TD021INT	400	350	100	305	50	-	384	Φ7	7.2
IS810N50M4TD026INT	400	350	100	305	50	-	384	Φ7	7.2
IS810N50M4TD032INT	400	350	100	305	50	-	384	Φ7	7.2
IS810N50M4TD037INT	400	350	100	305	50	-	384	Φ7	7.8

## Dimensions of rectifier units

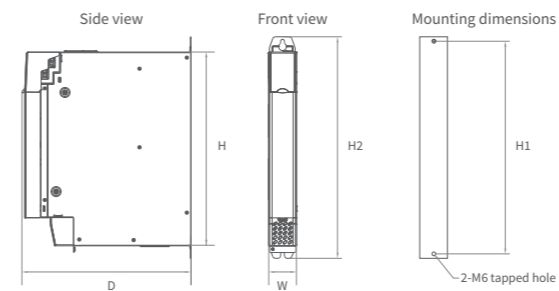

Rectifier unit model (size 1)	Physical dimensions (mm)				Mounting hole (mm)			Mounting hole diameter (mm)	Mass (kg)
	(H2)	(H)	(W)	(D)	(W1)	(W2)	(H1)		
MD810-20M4T22GXXX	400	350	50	305	-	-	384	Φ7	3.8

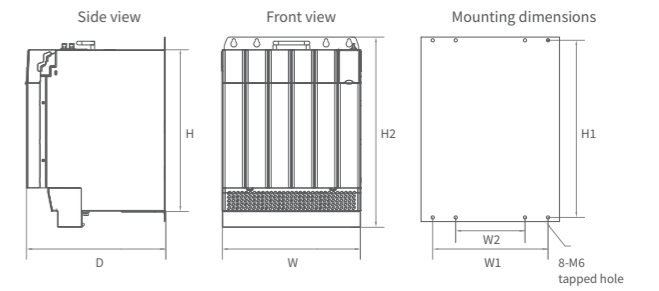

Rectifier unit model (size 4)	Physical dimensions (mm)				Mounting hole (mm)			Mounting hole diameter (mm)	Mass (kg)
	(H2)	(H)	(W)	(D)	(W1)	(W2)	(H1)		
MD810-20M4T160GXXX	400	350	300	305	250	150	384	Φ7	38

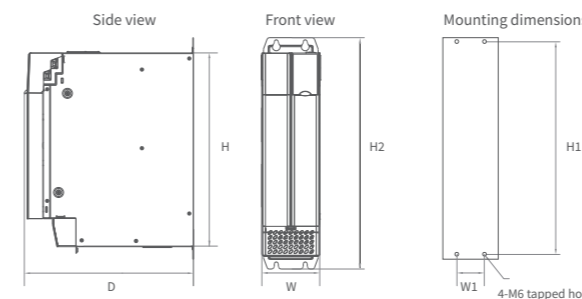

Rectifier unit model (size 2)	Physical dimensions (mm)				Mounting hole (mm)			Mounting hole diameter (mm)	Mass (kg)
	(H2)	(H)	(W)	(D)	(W1)	(W2)	(H1)		
MD810-20M4T45GXXX	400	350	100	305	50	-	384	Φ7	8

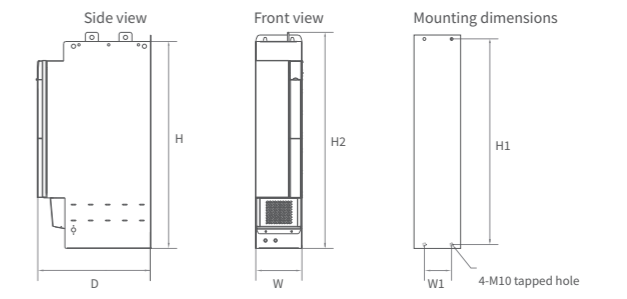

Rectifier unit model (size 5)	Physical dimensions (mm)				Mounting hole (mm)			Mounting hole diameter (mm)	Mass (kg)
	(H2)	(H)	(W)	(D)	(W1)	(W2)	(H1)		
MD810-20M4T355GXXX	835	800	180	445	105	-	795	Φ12	65

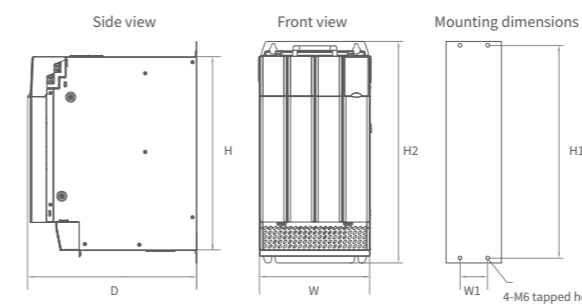

Rectifier unit model (size 3)	Physical dimensions (mm)				Mounting hole (mm)			Mounting hole diameter (mm)	Mass (kg)
	(H2)	(H)	(W)	(D)	(W1)	(W2)	(H1)		
MD810-20M4T110GXXX	400	350	200	305	150	-	384	Φ7	18.4



# IS810N-MS1 motor selection chart

Motor base speed (RPM)	Motor maximum speed (RPM)	Motor power (W)	Motor rated torque (N·m)	Motor peak torque (N·m)	Motor frame size (mm)	Rotor inertia (0.0001x kg·m <sup>2</sup> )	MS1 motor type	IS810N type**	IS810N rated current (A)	IS810N peak current (A)	Size	Dimensions H x W x D (mm)
3,000	6,000	50	0.16	0.56	40x40	0.026	MS1H1-05B30CB-A330Z	IS810N50M4T_3R5INT	3.5	8.50	1	400 x 50 x 305
3,000	6,000	100	0.32	1.12	40x40	0.041	MS1H1-10B30CB-A330Z	IS810N50M4T_3R5INT	3.5	8.50	1	400 x 50 x 305
3,000	6,000	200	0.64	2.24	60x60	0.207	MS1H1-20B30CB-A331Z	IS810N50M4T_3R5INT	3.5	8.50	1	400 x 50 x 305
3,000	6,000	400	1.27	3.75	60x60	0.376	MS1H1-40B30CB-A331Z	IS810N50M4T_3R5INT	3.5	8.50	1	400 x 50 x 305
3,000	6,000	400	1.27	4.46	60x60	0.376	MS1H1-40B30CB-A331Z	IS810N50M4T_5R4INT	5.4	14.00	1	400 x 50 x 305
3,000	6,000	400	1.27	3.75	60x60	0.657	MS1H4-40B30CB-A331Z	IS810N50M4T_3R5INT	3.5	8.50	1	400 x 50 x 305
3,000	6,000	400	1.27	4.46	60x60	0.657	MS1H4-40B30CB-A331Z	IS810N50M4T_5R4INT	5.4	14.00	1	400 x 50 x 305
3,000	6,000	550	1.75	5.72	80x80	1.06	MS1H1-55B30CB-A331Z*	IS810N50M4T_5R4INT	5.4	14.00	1	400 x 50 x 305
3,000	6,000	750	2.39	6.93	80x80	1.38	MS1H1-75B30CB-A331Z	IS810N50M4T_5R4INT	5.4	14.00	1	400 x 50 x 305
3,000	6,000	750	2.39	8.36	80x80	1.38	MS1H1-75B30CB-A331Z	IS810N50M4T_8R4INT	8.4	20.00	1	400 x 50 x 305
3,000	6,000	750	2.39	6.93	80x80	2	MS1H4-75B30CB-A331Z	IS810N50M4T_5R4INT	5.4	14.00	1	400 x 50 x 305
3,000	6,000	750	2.39	8.36	80x80	2	MS1H4-75B30CB-A331Z	IS810N50M4T_8R4INT	8.4	20.00	1	400 x 50 x 305
3,000	6,000	1,000	3.18	7.93	80x80	1.75	MS1H1-10C30CB-A331Z*	IS810N50M4T_8R4INT	8.4	20.00	1	400 x 50 x 305
3,000	6,000	1,000	3.18	11.10	80x80	1.75	MS1H1-10C30CB-A331Z*	IS810N50M4T_012INT	12.0	28.00	1	400 x 50 x 305
3,000	6,000	1,000	3.18	9.54	100x100	1.87	MS1H2-10C30CD-A331Z	IS810N50M4T_5R4INT	5.4	14.00	1	400 x 50 x 305
3,000	5,000	1,500	4.9	14.70	100x100	2.46	MS1H2-15C30CD-A331Z	IS810N50M4T_5R4INT	5.4	14.00	1	400 x 50 x 305
3,000	5,000	2,000	6.36	19.10	100x100	3.06	MS1H2-20C30CD-A331Z	IS810N50M4T_8R4INT	8.4	20.00	1	400 x 50 x 305
3,000	5,000	2,500	7.96	19.12	100x100	3.65	MS1H2-25C30CD-A331Z	IS810N50M4T_8R4INT	8.4	20.00	1	400 x 50 x 305
3,000	5,000	2,500	7.96	23.90	100x100	3.65	MS1H2-25C30CD-A331Z	IS810N50M4T_012INT	12.0	28.00	1	400 x 50 x 305
3,000	5,000	3,000	9.8	27.44	130x130	7.72	MS1H2-30C30CD-A331Z	IS810N50M4T_012INT	12.0	28.00	1	400 x 50 x 305
3,000	5,000	3,000	9.8	29.40	130x130	7.72	MS1H2-30C30CD-A331Z	IS810N50M4T_017INT	16.5	42.00	2	400 x 100 x 305
3,000	5,000	4,000	12.6	37.80	130x130	12.1	MS1H2-40C30CD-A331Z	IS810N50M4T_017INT	16.5	42.00	2	400 x 100 x 305
3,000	5,000	5,000	15.8	41.65	130x130	15.4	MS1H2-50C30CD-A331Z	IS810N50M4T_017INT	16.5	42.00	2	400 x 100 x 305
3,000	5,000	5,000	15.8	47.60	130x130	15.4	MS1H2-50C30CD-A331Z	IS810N50M4T_021INT	20.8	55.00	2	400 x 100 x 305
1,500	3,000	850	5.39	13.50	130x130	13.3	MS1H3-85B15CD-A331Z	IS810N50M4T_3R5INT	3.5	8.50	1	400 x 50 x 305
1,500	3,000	1,300	8.34	20.85	130x130	17.8	MS1H3-13C15CD-A331Z	IS810N50M4T_5R4INT	5.4	14.00	1	400 x 50 x 305
1,500	3,000	1,800	11.5	28.75	130x130	25	MS1H3-18C15CD-A331Z	IS810N50M4T_8R4INT	8.4	20.00	1	400 x 50 x 305
1,500	3,000	2,900	18.6	37.20	180x180	55	MS1H3-29C15CD-A331Z	IS810N50M4T_012INT	12.0	28.00	1	400 x 50 x 305
1,500	3,000	4,400	28.4	71.10	180x180	88.9	MS1H3-44C15CD-A331Z	IS810N50M4T_017INT	16.5	42.00	2	400 x 100 x 305
1,500	3,000	5,500	35	87.60	180x180	107	MS1H3-55C15CD-A331Z	IS810N50M4T_021INT	20.8	55.00	2	400 x 100 x 305
1,500	3,000	7,500	48	119.00	180x180	141	MS1H3-75C15CD-A331Z	IS810N50M4T_026INT	25.7	65.00	2	400 x 100 x 305

\*Motor does not have an option with a brake \*\*All drives are available in single axis (TS) or dual axes (TD)  
To select motors with higher ratings, please consult with your local Inovance representative

## MS1 motor Product ordering code

MS1 H1 - 40B 30C B - A3 3 1 Z - INT

① ② ③ ④ ⑤ ⑥ ⑦ ⑧ ⑨ ⑩

- ① **Motor series:**  
MS1 series servo motor
- ② **Type:**  
H1: low inertia, small capacity  
H2: low inertia, medium capacity  
H3: medium inertia, medium capacity  
H4: medium inertia, small capacity
- ③ **Rated power (W)**  
One number and one letter  
A: x1  
B: x10  
C: x100  
D: x1000  
E: x10000  
Example: 40B: 400 W
- ④ **Rated speed (RPM)**  
One number and one letter  
A: x1  
B: x10  
C: x100  
D: x1000  
E: x10000  
e.g. 30C: 3000 RPM
- ⑤ **Voltage class**  
B: 220 V  
D: 380 V
- ⑥ **Encoder type**  
One number and one letter  
A3: multi-turn absolute encoder
- ⑦ **Shaft connection mode**  
1: plain shaft  
2: solid, keyed  
3: solid, keyed with threaded holes  
5: solid with threaded holes
- ⑧ **Brake, reducer and oil seal**  
0: none  
1: oil seal  
2: brake  
4: oil seal and brake
- ⑨ **Motor specification**  
Z: terminal type
- ⑩ **Model:**  
INT: international edition

# IS810N-ISMG motor selection chart

Motor base speed (RPM)	Motor maximum speed (RPM)	Motor power (kW) S1 duty	Motor power (kW) S4 duty	Motor rated torque (N·m) S1 duty	Motor rated torque (N·m) S4 duty	Motor peak torque (N·m)	Motor frame size (mm)	Rotor inertia (0.0001x kg·m <sup>2</sup> )	ISMG motor type	IS810N type	IS810N rated current (A)	IS810N peak current (A)	Size	Dimensions H x W x D (mm)
1500	1800	7.9	9.5	50	60	135	200x200	75	ISMG1-95C15CD-A331FA	IS810N50M4T_017INT**	16.5	42	2	400 x 100 x 305
2000	2400	10.5	12	50	60	135	200x200	75	ISMG1-12D20CD-A331FA	IS810N50M4T_021INT**	20.8	55	2	400 x 100 x 305
1500	1800	11.8	14	75	90	203	200x200	90	ISMG1-14D15CD-A331FA	IS810N50M4T_026INT**	25.7	65	2	400 x 100 x 305
1500	1800	14.5	17	92	110	248	200x200	105	ISMG1-17D15CD-A331FA	IS810N50M4T_032INT**	32	80	2	400 x 100 x 305
2000	2400	15.7	18	75	90	203	200x200	90	ISMG1-18D20CD-A331FA	IS810N50M4T_032INT**	32	80	2	400 x 100 x 305
1500	1800	18.1	22	115	135	311	200x200	120	ISMG1-22D15CD-A331FA	IS810N50M4T_037INT**	37	92.5	2	400 x 100 x 305
2000	2400	19.3	23	92	110	248	200x200	105	ISMG1-23D20CD-A331FA	IS810N50M4TS075INT-P	75	187.5	3	400 x 200 x 305
2000	2400	24.1	28	115	135	311	200x200	120	ISMG1-28D20CD-A331FA	IS810N50M4TS075INT-P	75	187.5	3	400 x 200 x 305
1500	1800	23.6	30	150	195	405	200x200	150	ISMG1-30D15CD-A331FA	IS810N50M4TS075INT-P	75	187.5	3	400 x 200 x 305
2000	2400	31.4	41	150	195	405	200x200	150	ISMG1-41D20CD-A331FA*	IS810N50M4TS075INT-P	75	187.5	3	400 x 200 x 305
1500	1800	26.7	31	170	200	366	266x266	296	ISMG2-31D15CD-A331FA*	IS810N50M4TS075INT-P	75	187.5	3	400 x 200 x 305
2000	2400	35.6	42	170	200	366	266x266	296	ISMG2-42D20CD-A331FA*	IS810N50M4TS075INT-P	75	187.5	3	400 x 200 x 305
1500	1800	36.1	42	230	270	495	266x266	368	ISMG2-42D15CD-A331FA*	IS810N50M4TS075INT-P	75	187.5	3	400 x 200 x 305
1500	1800	44.8	52	285	335	613	266x266	434	ISMG2-52D15CD-A331FA*	IS810N50M4TS090INT	91	227.5	3	400 x 200 x 305
2000	2400	48.2	57	230	270	495	266x266	368	ISMG2-57D20CD-A331FA*	IS810N50M4TS090INT	91	227.5	3	400 x 200 x 305
1500	1800	53.4	60	340	385	731	266x266	500	ISMG2-60D15CD-A331FA*	IS810N50M4TS112INT	112	280	3	400 x 200 x 305
2000	2400	59.7	70	285	335	613	266x266	434	ISMG2-70D20CD-A331FA*	IS810N50M4TS152INT	152	380	3	400 x 200 x 305
2000	2400	71.2	80	340	385	731	266x266	500	ISMG2-80D20CD-A331FA*	IS810N50M4TS152INT	152	380	3	400 x 200 x 305
1500	1800	69.1	80	440	510	946	266x266	640	ISMG2-80D15CD-A331FA*	IS810N50M4TS152INT	152	380	3	400 x 200 x 305

\* Motor does not have an option with a brake  
\*\* These drives are available in single axis (TS) or dual axes (TD)



## ISMG motor Product ordering code

ISM G1 - 95C 15C D - A3 3 1 F A

① ② ③ ④ ⑤ ⑥ ⑦ ⑧ ⑨ ⑩

- ① **Product series:**  
ISM: ISM series servo motor
- ② **Flange size (mm):**  
G1: 200 x 200  
G2: 266 x 266
- ③ **Rated Power (W)**  
C: x 100  
D: x 1000
- ④ **Rated speed (rpm)**  
C: x 100  
D: x 1000
- ⑤ **Voltage class**  
B: 220 V  
D: 380 V
- ⑥ **Encoder type**  
A3: 23-bit absolute  
R1: Resolver
- ⑦ **Shaft connection**  
3: Keyed + tapped hole  
A: Keyed + tapped hole salent-pole motor
- ⑧ **Brake, gear, oil seal**  
1: Oil seal  
4: Oil seal + brake
- ⑨ **Customised feature**  
F: Forced ventilation
- ⑩ **Version**  
A: Version A



# IS810N

## Cable selection chart

IS810N drive type code	Servo motor type code	23 bit multi-turn encoder cables*	Power cables for motors without brake**	Power cables for motors with brake**
IS810N50M4TD3R5INT dual axis	MS1H3-85B15CD-XXXXZ	S6-L-P021-XX.X-YY-INT	S6-L-M111-XX.X-ZZ-INT	S6-L-B111-XX.X-ZZ-INT
IS810N50M4TD3R5INT dual axis	MS1H1-05B30CB-XXXXZ	S6-L-P024-XX.X-YY-INT (front outlet) S6-L-P025-XX.X-YY-INT (back outlet)	S6-L-M107-XX.X-ZZ-INT (front outlet) S6-L-M108-XX.X-ZZ-INT (back outlet)	S6-L-B107-XX.X-ZZ-INT (front outlet) S6-L-B108-XX.X-ZZ-INT (back outlet)
IS810N50M4TD3R5INT dual axis	MS1H1-10B30CB-XXXXZ	S6-L-P024-XX.X-YY-INT (front outlet) S6-L-P025-XX.X-YY-INT (back outlet)	S6-L-M107-XX.X-ZZ-INT (front outlet) S6-L-M108-XX.X-ZZ-INT (back outlet)	S6-L-B107-XX.X-ZZ-INT (front outlet) S6-L-B108-XX.X-ZZ-INT (back outlet)
IS810N50M4TD3R5INT dual axis	MS1H1-20B30CB-XXXXZ	S6-L-P024-XX.X-YY-INT (front outlet) S6-L-P025-XX.X-YY-INT (back outlet)	S6-L-M107-XX.X-ZZ-INT (front outlet) S6-L-M108-XX.X-ZZ-INT (back outlet)	S6-L-B107-XX.X-ZZ-INT (front outlet) S6-L-B108-XX.X-ZZ-INT (back outlet)
IS810N50M4TD3R5INT dual axis	MS1H1-40B30CB-XXXXZ	S6-L-P024-XX.X-YY-INT (front outlet) S6-L-P025-XX.X-YY-INT (back outlet)	S6-L-M107-XX.X-ZZ-INT (front outlet) S6-L-M108-XX.X-ZZ-INT (back outlet)	S6-L-B107-XX.X-ZZ-INT (front outlet) S6-L-B108-XX.X-ZZ-INT (back outlet)
IS810N50M4TD3R5INT dual axis	MS1H4-40B30CB-XXXXZ	S6-L-P024-XX.X-YY-INT (front outlet) S6-L-P025-XX.X-YY-INT (back outlet)	S6-L-M107-XX.X-ZZ-INT (front outlet) S6-L-M108-XX.X-ZZ-INT (back outlet)	S6-L-B107-XX.X-ZZ-INT (front outlet) S6-L-B108XX.X-ZZ-INT (back outlet)
IS810N50M4TD5R4INT dual axis	MS1H2-10C30CD-XXXXZ	S6-L-P021-XX.X-YY-INT	S6-L-M111-XX.X-ZZ-INT	S6-L-B111-XX.X-ZZ-INT
IS810N50M4TD5R4INT dual axis	MS1H2-15C30CD-XXXXZ	S6-L-P021-XX.X-YY-INT	S6-L-M111-XX.X-ZZ-INT	S6-L-B111-XX.X-ZZ-INT
IS810N50M4TD5R4INT dual axis	MS1H3-13C15CD-XXXXZ	S6-L-P021-XX.X-YY-INT	S6-L-M111-XX.X-ZZ-INT	S6-L-B111-XX.X-ZZ-INT
IS810N50M4TD5R4INT dual axis	MS1H1-55B30CB-XXXXZ	S6-L-P024-XX.X-YY-INT (front outlet) S6-L-P025-XX.X-YY-INT (back outlet)	S6-L-M107-XX.X-ZZ-INT (front outlet) S6-L-M108-XX.X-ZZ-INT (back outlet)	S6-L-B107-XX.X-ZZ-INT (front outlet) S6-L-B108-XX.X-ZZ-INT (back outlet)
IS810N50M4TD5R4INT dual axis	MS1H1-75B30CB-XXXXZ	S6-L-P024-XX.X-YY-INT (front outlet) S6-L-P025-XX.X-YY-INT (back outlet)	S6-L-M107-XX.X-ZZ-INT (front outlet) S6-L-M108-XX.X-ZZ-INT (back outlet)	S6-L-B107-XX.X-ZZ-INT (front outlet) S6-L-B108-XX.X-ZZ-INT (back outlet)
IS810N50M4TD5R4INT dual axis	MS1H4-75B30CB-XXXXZ	S6-L-P024-XX.X-YY-INT (front outlet) S6-L-P025-XX.X-YY-INT (back outlet)	S6-L-M107-XX.X-ZZ-INT (front outlet) S6-L-M108-XX.X-ZZ-INT (back outlet)	S6-L-B107-XX.X-ZZ-INT (front outlet) S6-L-B108-XX.X-ZZ-INT (back outlet)
IS810N50M4TD8R4INT dual axis	MS1H2-10C30CD-XXXXZ	S6-L-P021-XX.X-YY-INT	S6-L-M111-XX.X-ZZ-INT	S6-L-B111-XX.X-ZZ-INT
IS810N50M4TD8R4INT dual axis	MS1H2-20C30CD-XXXXZ	S6-L-P021-XX.X-YY-INT	S6-L-M111-XX.X-ZZ-INT	S6-L-B111-XX.X-ZZ-INT
IS810N50M4TD8R4INT dual axis	MS1H2-25C30CD-XXXXZ	S6-L-P021-XX.X-YY-INT	S6-L-M111-XX.X-ZZ-INT	S6-L-B111-XX.X-ZZ-INT
IS810N50M4TD8R4INT dual axis	MS1H3-18C15CD-XXXXZ	S6-L-P021-XX.X-YY-INT	S6-L-M111-XX.X-ZZ-INT	S6-L-B111-XX.X-ZZ-INT
IS810N50M4TD8R4INT dual axis	MS1H3-85B15CB-XXXXZ	S6-L-P021-XX.X-YY-INT	S6-L-M111-XX.X-ZZ-INT	S6-L-B111-XX.X-ZZ-INT
IS810N50M4TD8R4INT dual axis	MS1H1-10C30CB-XXXXZ	S6-L-P024-XX.X-YY-INT (front outlet) S6-L-P025-XX.X-YY-INT (back outlet)	S6-L-M107-XX.X-ZZ-INT (front outlet) S6-L-M108-XX.X-ZZ-INT (back outlet)	S6-L-B107-XX.X-ZZ-INT (front outlet) S6-L-B108-XX.X-ZZ-INT (back outlet)
IS810N50M4TD012INT dual axis	MS1H2-15C30CB-XXXXZ	S6-L-P021-XX.X-YY-INT	S6-L-M111-XX.X-ZZ-INT	S6-L-B111-XX.X-ZZ-INT
IS810N50M4TD012INT dual axis	MS1H2-30C30CD-XXXXZ	S6-L-P021-XX.X-YY-INT	S6-L-M111-XX.X-ZZ-INT	S6-L-B111-XX.X-ZZ-INT
IS810N50M4TD012INT dual axis	MS1H3-13C15CB-XXXXZ	S6-L-P021-XX.X-YY-INT	S6-L-M111-XX.X-ZZ-INT	S6-L-B111-XX.X-ZZ-INT
IS810N50M4TD012INT dual axis	MS1H3-29C15CD-XXXXZ	S6-L-P021-XX.X-YY-INT	S6-L-M122-XX.X-ZZ-INT	S6-L-B122-XX.X-ZZ-INT
IS810N50M4TD017INT dual axis	ISMG1-95C15CD-XXXXFA	S6-L-P021-XX.X-YY-INT	Custom made	Custom made
IS810N50M4TD017INT dual axis	MS1H2-40C30CD-XXXXZ	S6-L-P021-XX.X-YY-INT	S6-L-M111-XX.X-ZZ-INT	S6-L-B111-XX.X-ZZ-INT
IS810N50M4TD017INT dual axis	MS1H2-50C30CD-XXXXZ	S6-L-P021-XX.X-YY-INT	S6-L-M111-XX.X-ZZ-INT	S6-L-B111-XX.X-ZZ-INT
IS810N50M4TD017INT dual axis	MS1H3-44C15CD-XXXXZ	S6-L-P021-XX.X-YY-INT	S6-L-M122-XX.X-ZZ-INT	S6-L-B122-XX.X-ZZ-INT
IS810N50M4TD021INT dual axis	ISMG1-12D20CD-XXXXFA	S6-L-P021-XX.X-YY-INT	Custom made	Custom made
IS810N50M4TD021INT dual axis	MS1H3-55C15CD-XXXXZ	S6-L-P021-XX.X-YY-INT	S6-L-M122-XX.X-ZZ-INT	S6-L-B122-XX.X-ZZ-INT
IS810N50M4TD026INT dual axis	ISMG1-14D15CD-XXXXFA	S6-L-P021-XX.X-YY-INT	Custom made	Custom made
IS810N50M4TD026INT dual axis	MS1H3-75C15CD-XXXXZ	S6-L-P021-XX.X-YY-INT	S6-L-M122-XX.X-ZZ-INT	S6-L-B122-XX.X-ZZ-INT
IS810N50M4TD032INT dual axis	ISMG1-17D15CD-XXXXFA	S6-L-P021-XX.X-YY-INT	Custom made	Custom made
IS810N50M4TD032INT dual axis	ISMG1-18D20CD-XXXXFA	S6-L-P021-XX.X-YY-INT	Custom made	Custom made
IS810N50M4TD037INT dual axis	ISMG1-22D15CD-XXXXFA	S6-L-P021-XX.X-YY-INT	Custom made	Custom made
IS810N50M4TS075INT-P single axis	ISMG1-23D20CD-XXXXFA	S6-L-P021-XX.X-YY-INT	Custom made	Custom made
IS810N50M4TS075INT-P single axis	ISMG1-28D20CD-XXXXFA	S6-L-P021-XX.X-YY-INT	Custom made	Custom made
IS810N50M4TS075INT-P single axis	ISMG1-30D15CD-XXXXFA	S6-L-P021-XX.X-YY-INT	Custom made	Custom made
IS810N50M4TS075INT-P single axis	ISMG1-41D20CD-XXXXFA	S6-L-P021-XX.X-YY-INT	Custom made	Custom made
IS810N50M4TS075INT-P single axis	ISMG2-31D15CD-XXXXFA	S6-L-P021-XX.X-YY-INT	Custom made	Custom made
IS810N50M4TS075INT-P single axis	ISMG2-42D15CD-XXXXFA	S6-L-P021-XX.X-YY-INT	Custom made	Custom made
IS810N50M4TS075INT-P single axis	ISMG2-42D20CD-XXXXFA	S6-L-P021-XX.X-YY-INT	Custom made	Custom made
IS810N50M4TS091INT single axis	ISMG2-52D15CD-XXXXFA	S6-L-P021-XX.X-YY-INT	Custom made	Custom made
IS810N50M4TS091INT single axis	ISMG2-57D20CD-XXXXFA	S6-L-P-21-XX.X-YY-INT	Custom made	Custom made
IS810N50M4TS112INT single axis	ISMG2-60D15CD-XXXXFA	S6-L-P021-XX.X-YY-INT	Custom made	Custom made
IS810N50M4TS152INT single axis	ISMG2-70D20CD-XXXXFA	S6-L-P021-XX.X-YY-INT	Custom made	Custom made
IS810N50M4TS152INT single axis	ISMG2-80D15CD-XXXXFA	S6-L-P021-XX.X-YY-INT	Custom made	Custom made
IS810N50M4TS152INT single axis	ISMG2-80D20CD-XXXXFA	S6-L-P021-XX.X-YY-INT	Custom made	Custom made
IS810N50M4TS152INT single axis	ISMG2-94D15CD-XXXXFA	S6-L-P021-XX.X-YY-INT	Custom made	Custom made

**Notes:**

In all part codes throughout this table:

- XX.X indicates the cable length. Standard specifications are 3.0 m, 5.0 m, 10.0 m. Customized lengths and specifications documents are available on request.
- S6 can be replaced by S6E or S6I according to customer requirements. Consult with your local Inovance representative for more information.

\*Throughout this column, YY in the part number can be replaced with either TO for PVC cable or U for PUR cable, according to customer requirements.

\*\* Throughout this column, ZZ in the part number can be replaced with either TS for PVC cable or US for PUR cable.



## Communications cables

Cable type	Item code	L (mm)	Appearance
Ethernet communications cable	S6-L-T04-0.3	300	
	S6-L-T04-3.0	3,000	

## Connector and battery kits

Model	Connector kit:	Battery set for absolute encoder back up
MS1H2	S6-C2 (CN1 & CN2 terminal, 20-18 pin & 20-29 pin connector)	S6-C9 S6-C9-NB (without battery)
MS1H3 (1.8 kW & below)	S6-C2 (CN1 & CN2 terminal, 20-18 pin & 20-29 pin connector)	
MS1H3 (2.9 kW)	S6-C3 (CN1 & CN2 terminal, 20-22 pin & 20-29 pin connector)	
MS1H3 (above 2.9 kW)		



# Driven by Technology

AC drives



AC MultiDrives



MV drives



Single-Axis servos



Multi-Axis servos



Robotics & motion controllers



PLCs & HMIs



CNC machine tool solutions



Electric vehicle inverters

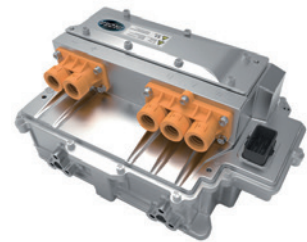

## International Offices



### Germany-Stuttgart

Tel: +49 (0) 7144 8990 | sales.de@inovance.eu



### Italy-Milano

Tel: +39 (0) 2268 22318 | sales.it@inovance.eu



### France-Bordeaux



Tel: +33 (0) 5594 01050 | sales.fr@inovance.eu



### Turkey-Istanbul

Tel: +90 (216) 706 17 89 | info@inovance.eu

### South Korea-Seoul

Tel: +82 (0) 10 7428 5732 | info@inovance.eu

## Hong Kong SAR

### International Export Office

Tel: +852 2751 6080

info@inovance.eu



## India

Head Office Chennai | Tel: +91 (0) 44 4380 0201

Ahmedabad | Tel: +91 794003 4272

Mumbai | Tel: +91 22 4971 5883

New Delhi | Tel: +91 11 4165 4524

### Sales Network

in Kolkata, Bengaluru, Pune, Coimbatore,

Hyderabad, Vadodara, Jaipur

Email: info@inovance.ind.in

For other country distributors,  
contact the Hong Kong office.

**Inovance Technology Companies**

Shenzhen Inovance Technology Co. Ltd.

Suzhou Inovance Technology Co. Ltd.

**INOVANCE**  
www.inovance.eu